

Part# 42648
 EX-SFP-10GE-DAC-5M-LEG
 JUNIPER NETWORKS COMPATIBLE 10GBASE-CU SFP+ DAC
 5M DAC PASSIVE



Features

- Support for multi-gigabit data rates up to 10 Gb/s
- Data rates backward compatible to 1 Gb/s
- Hot-Pluggable SFP 20PIN footprint
- Improved Pluggable Form Factor (IPF) compliant for enhanced EMI/EMC performance
- Compatible to SFP+ MSA
- Compatible to SFF-8431, SFF-8432
- Temperature Range: 0~70°C
- RoHS Compatible



Application

- High Capacity I/O in Storage Area Networks, Network Attached Storage, and Storage Servers
- Switched fabric I/O such as ultra high bandwidth switches and routers
- Data center cabling infrastructure
- High density connections between networking equipment

Product Description

The EX-SFP-10GE-DAC-5M-LEG passive cable assemblies are high performance, cost effective I/O solutions for 10G Ethernet and 10G Fiber Channel applications. SFP+ copper modules allow hardware manufactures to achieve high port density, configurability and utilization at a very low cast and reduced power budget. The high speed cable Assemblies meet and exceed Gigabit Ethernet and Fiber channel industry standard requirements for performance and reliability.

Recommended Operating conditions

Parameter	Symbol	Min	Typ.	Max.	Unit
Storage Temperature		-40		85	°C
Operating Case Temperature	Tc	0		70	°C

Systems

Parameter	Media
10 Gb/s line speed, full duplex Bit error rate: better than 10E-12	Hot-pluggable, industry-standard Small Form-Factor Pluggable (SFP+) copper cable, available as 7m.

Pin Descriptions

Pin	Logic	Symbol	Name/Description	Notes
1		VeeT	Transmitter Ground	
2	LV-TTL-O	TX_Fault	N/A	1
3	LV-TTL-I	TX_DIS	Transmitter Disable	2
4	LV-TTL-I/O	SDA	Tow Wire Serial Data	
5	LV-TTL-I	SCL	Tow Wire Serial Clock	
6		MOD_DEF0	Module present, connect to VeeT	
7	LV-TTL-I	RS0	N/A	1
8	LV-TTL-O	LOS	LOS of Signal	2
9	LV-TTL-I	RS1	N/A	1
10		VeeR	Receiver Ground	
11		VeeR	Receiver Ground	
12	CML-O	RD-	Receiver Data Inverted	
13	CML-O	RD+	Receiver Data Non-inverted	
14		VeeR	Receiver Ground	
15		VccR	Receiver Supply 3.3V	
16		VccT	Transmitter Supply 3.3V	
17		VeeT	Transmitter Ground	
18	CML-I	TD+	Transmitter Data Non-Inverted	
19	CML_I	TD-	Transmitter Data Inverted	
20		VeeT	Transmitter Ground	

Note:

1. Signals not supported in SFP+ Copper pulled-down to VeeT with 30K ohms resistor
2. Passive Cable assemblies do not support LOS and TX_DIS

Mechanical Specification

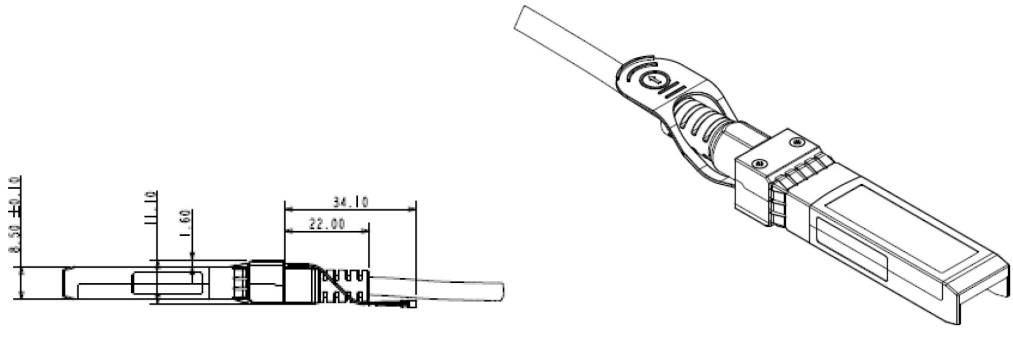
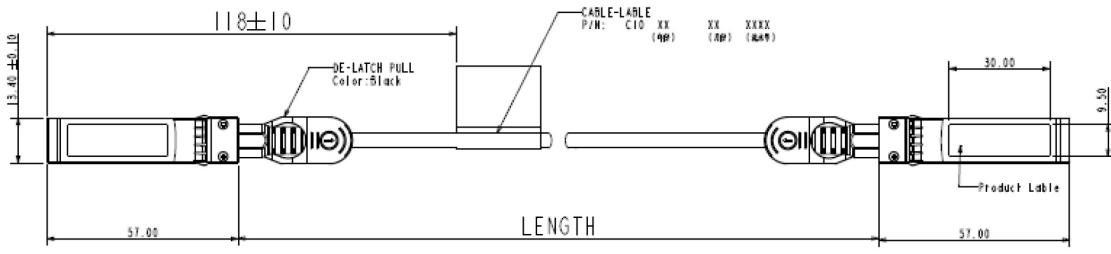

3555 Kettering Blvd.
 Moraine, OH 45439
 800.CABL.911
 www.c2g.com