

**Part# 42615**  
 SFP-10G-PDAC7M-LEG  
 10GBASE-CU SFP+ DAC  
 7M DAC PASSIVE



**Features**

- Support for multi-gigabit data rates up to 10 Gb/s
- Data rates backward compatible to 1 Gb/s
- Hot-Pluggable SFP 20PIN footprint
- Improved Pluggable Form Factor (IPF) compliant for enhanced EMI/EMC performance
- Compatible to SFP+ MSA
- Compatible to SFF-8431, SFF-8432
- Temperature Range: 0~70°C
- RoHS Compatible

**Application**

- High Capacity I/O in Storage Area Networks, Network Attached Storage, and Storage Servers
- Switched fabric I/O such as ultra high bandwidth switches and routers
- Data center cabling infrastructure
- High density connections between networking equipment

**Product Description**

The SFP-10G-PDAC7M-LEG passive cable assemblies are high performance, cost effective I/O solutions for 10G Ethernet and 10G Fiber Channel applications. SFP+ copper modules allow hardware manufactures to achieve high port density, configurability and utilization at a very low cast and reduced power budget. The high speed cable Assemblies meet and exceed Gigabit Ethernet and Fiber channel industry standard requirements for performance and reliability.

**Recommended Operating conditions**

Parameter	Symbol	Min	Typ.	Max.	Unit
Storage Temperature		-40		85	°C
Operating Case Temperature	Tc	0		70	°C

## Systems

Parameter	Media
10 Gb/s line speed, full duplex Bit error rate: better than 10E-12	Hot-pluggable, industry-standard Small Form-Factor Pluggable (SFP+) copper cable, available as 7m.

## Pin Descriptions

Pin	Logic	Symbol	Name/Description	Notes
1		VeeT	Transmitter Ground	
2	LV-TTL-O	TX_Fault	N/A	1
3	LV-TTL-I	TX_DIS	Transmitter Disable	2
4	LV-TTL-I/O	SDA	Tow Wire Serial Data	
5	LV-TTL-I	SCL	Tow Wire Serial Clock	
6		MOD_DEF0	Module present, connect to VeeT	
7	LV-TTL-I	RS0	N/A	1
8	LV-TTL-O	LOS	LOS of Signal	2
9	LV-TTL-I	RS1	N/A	1
10		VeeR	Receiver Ground	
11		VeeR	Receiver Ground	
12	CML-O	RD-	Receiver Data Inverted	
13	CML-O	RD+	Receiver Data Non-inverted	
14		VeeR	Receiver Ground	
15		VccR	Receiver Supply 3.3V	
16		VccT	Transmitter Supply 3.3V	
17		VeeT	Transmitter Ground	
18	CML-I	TD+	Transmitter Data Non-Inverted	
19	CML_I	TD-	Transmitter Data Inverted	
20		VeeT	Transmitter Ground	

### Note:

1. Signals not supported in SFP+ Copper pulled-down to VeeT with 30K ohms resistor
2. Passive Cable assemblies do not support LOS and TX\_DIS

# Mechanical Specification

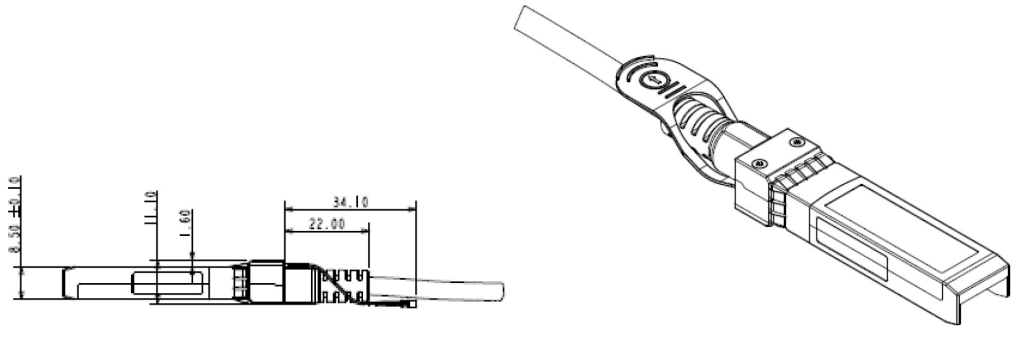
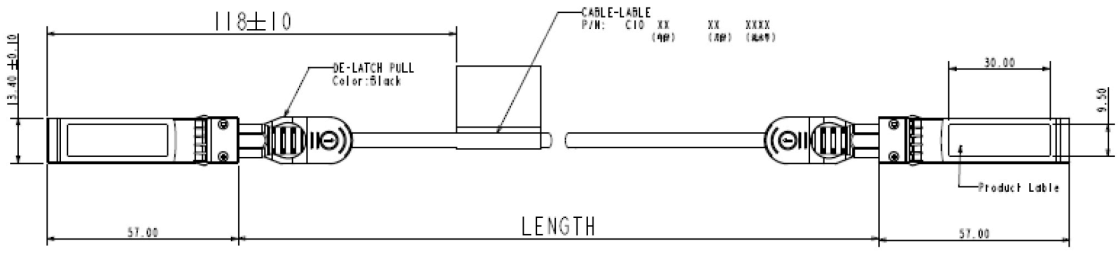

3555 Kettering Blvd.  
 Moraine, OH 45439  
 800.CABL.911  
 www.c2g.com